



# **LL-LMB 100G**

**GREEN FAT-BEAM MOVING HEAD LASER LIGHT**

***User's Manual***





Read this manual before using. Do not attempt to open the housing or repair this device by yourself without contact us!

### *Troubleshooting*

1. If the power supply indicator doesn't light up and the laser doesn't work, please check the power supply, the input voltage and the fuse.
2. In Stand-Alone operation, if the power supply indicator is light up and sound active indicator isn't light up, but the laser is shut off doesn't work.
  - A. Because sound is too small make for laser shut off in sound active, please increase the music volume or increase audio sensitivity with sensitivity knob, please check as below.
  - B. Please check if unit has been set up in slave mode, then set up in master mode.
3. In Master-Slave operation, slave unit don't function, please check as below.
  - A. Make sure to there's only one master in the chain, and the others are set in slave mode.
  - B. Make sure to control the unit without DMX console controlling.
  - C. Make sure to take a good quality power cable and connection.
4. In DMX mode operation, the laser is OFF and the DMX signal indicator is unlighted, please check as below.
  - A. Make sure to set up the DMX mode.
  - B. Make sure to have a good connection.
5. In DMX operation, the unit can't be controlled by the DMX console, but the DMX signal indicator is flashing, please make sure the DMX console and unit have the same channel.
6. If the unit is fail, please turn off the unit, then turn on again after 5 minutes.

### **Warranty Warnings:**

1. Damages caused by the disregard of this user manual are not subject to Warranty.
2. Please consider that unauthorized modifications on the device are forbidden due to safety reasons. Please note that damages caused by manual modifications on the device or unauthorized operation by unqualified persons are not subject to warranty.
3. If this device will be operated in any way different to the one described in this manual, it may suffer damages and the guarantee becomes void. Furthermore, any other operation may lead to dangers like short-circuit, burns electric shock, etc.

After trying the above solution you still have a problem, please contact your dealer or our company for service.

## General instructions

### Unpacking:

Thank you for purchasing this product. Please read user guide for safety and before using the product. Keep this manual for future reference. This product can create perfect laser programs and effects since it has passed a series of strictly tests before delivery. Please check the attachments listed on the page after opening the carton. Immediately upon receiving a fixture, carefully unpack the box. Check the box contents to ensure that all parts are present and that they are in good condition. If any part appears damaged from shipping, or if the box shows signs of mishandling, notify the shipper immediately. In addition, retain the box and all the packing material for inspection. In any event, save the carton and all packing material because, in case that you have to return the fixture to the factory, you will have to do so in its original box, with its original packing.

1. Laser Light: 1PCS 2. Power Cable: 1PCS 3. User Guide: 1PCS

### Laser Expected Lifespan

Laser gradually decline in brightness over time. HEAT is the dominant factor that leads to the acceleration of this decline. Packaged in clusters, laser exhibit higher operating temperatures than in ideal or singular optimum conditions. For this reason when all color lasers are used at their fullest intensity, life of the laser is significantly reduced. It is estimated that a viable lifespan of 4,000 to 10,000 hours will be achieved under normal operational conditions. If improving on this lifespan expectancy is of a higher priority, place care in providing for lower operational temperatures. This may include climatic-environmental and the reduction of overall projection intensity.

### Safety Notice:

Please read the following notes carefully because they include important safety information about the installation, usage and maintenance of this product. It is important to read all these notes before starting to work with this product.

Lasers can be hazardous and have unique safety considerations. Permanent eye injury and blindness is possible if lasers are used incorrectly. Pay close attention to each safety REMARK and WARNING statement in the user manual. Read all instructions careful.



There are no user serviceable parts inside the light. Any reference to servicing this unit you may find from now on in this User Manual will only apply to properly consult we certified technicians. Do not open the housing or attempt any repairs unless you

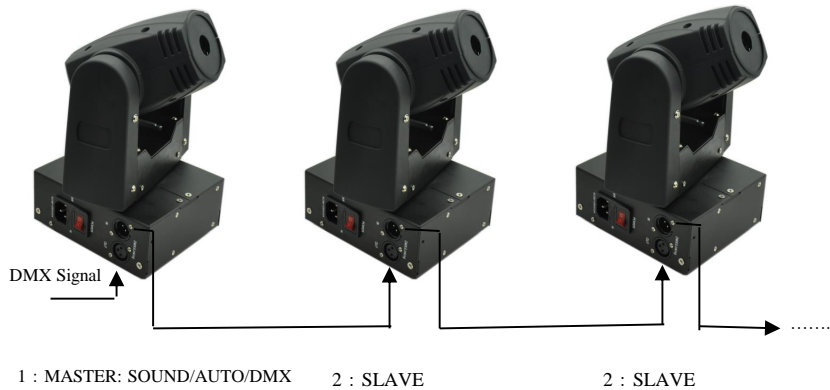













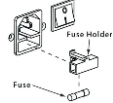

### DMX Control

The system only accepts the DMX512 signal of international standard to control the system mode, the laser beam ON /OFF, running direction, running speed and twinkle speed etc.

The system only accepts the DMX512 signal of international standard to control the system.

**DMX Control Parameter Chart**

Channel	Function	Value	Description
CH1	Mode	0~63	Close, laser OFF
		64~127	Sound active mode
		128~191	AUTO mode
		192~255	DMX mode
CH2	X Position	0~255	0 to 540°
CH3	X Speed	0~255	Slow to Speedy
CH4	Vertical Position	0~255	0 to 270°
CH5	Vertical Speed	0~255	Slow to Speedy
CH6	Laser diode	0~63	Laser OFF
		64~127	Laser ON
		128~191	AUTO Flash
		192~255	Sound active Flash

	Avoid direct eye exposure to the light source while the fixture is on. Always disconnect the light from its power source before servicing. Always connect the light to a grounded circuit to avoid the risk of electrocution.		
	This product is for indoor use only! Use only in dry locations. Keep this device away from rain and moisture, excessive heat, humidity and dust. Do not allow contact with water or any other fluids, or metallic objects.		
<b>Power</b> 110V 240V Ground	Always make sure that you are connecting the light to the proper voltage, as per the specifications in this manual or on the product's sticker. Never connect the light to a dimmer pack. Make sure that the power cable is not cracked, crimped or damaged. Ne		
	The maximum ambient temperature (Ta) is 104 F (40 C). Do not operate the fixture at a higher temperature. In case of a serious operating problem, stop using this product immediately!		
	Do not remove or break the warranty label, otherwise it void the warranty.		
	Always replace with the exact same type fuse, replacement with anything other than the specified fuse can cause fire or electric shock and damage your unit, and will void your manufactures warranty.		
	There are no serviceable parts in the light. Please have all servicing and adjustments made by a qualified service engineer.		
	Please refer to all applicable local codes and regulations for proper installation of the light.		Keep this manual for future consultation. If you sell the light to another user, make sure that they also receive this manual.
	Make sure there are no flammable materials close to the fixture(s) while operating.		Please prevent this light away from electrical shock
	When hanging this fixture, always secure it to a fastening device using a safety cable (not provided).		Use cleaning tissue to remove the dust absorbed on the external lenses periodically to optimize light output.
	Don't throw this product away just as general trash, please dispose of this product following the abandon electronic product regulation in your country.		To protect the environment, recycle packing material wherever possible.

3. Use standard XLR microphone cable chain your units together via the XLR connector on the rear of the units. For longer cable runs we suggest a terminator at the last fixture. Cabling must have a male XLR connector on one end and a female XLR connector on the other end.

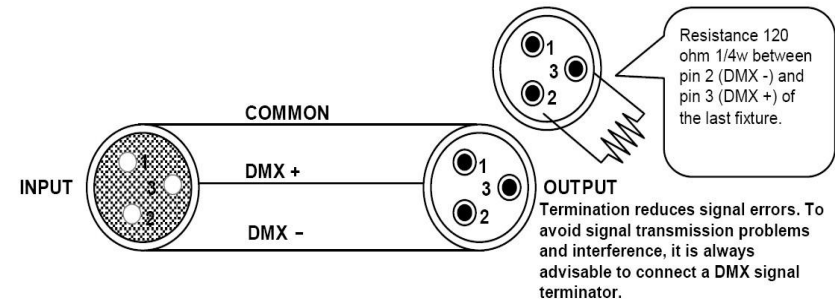

**Caution:** Do not allow contact between the common and the fixture's chassis ground. Grounding the common can cause a ground loop, and your fixture may perform erratically. Test cables with an ohm meter to verify correct polarity and to make sure the pins are not grounded or shorted to the shield or each other.

4. Turn on the all units' power, the units begins reset, then the unit begins working.

The slave units will react the same as the master unit.

5. The units will react to the low frequencies of music via the internal microphone.

Adjust the audio sensitivity knob on the back of the master unit to make the unit more or less sensitive in sound active. The panel has LED indicating for sound active.

Universal DMX Operation (DMX mode)

This mode allows you to use universal DMX-512 console to operate.

1. Install the units in a suitable position (laying or appending).
2. Use standard XLR microphone cable chain your units together via the XLR connector on the rear of the units. For longer cable runs we suggest a terminator at the last fixture.
3. Assign a DMX address to each the unit using dipswitches, see the "DMX Address Quick Reference Char".
4. Turn on the all units' power, the units begins reset, then the unit begins working.
5. Use DMX console to control your units.

Notes:

1. DMX console can not be used in Master-Slave operation (Sound Active or AUTO mode ).
2. There should be only one master unit in Master-Slave operation.

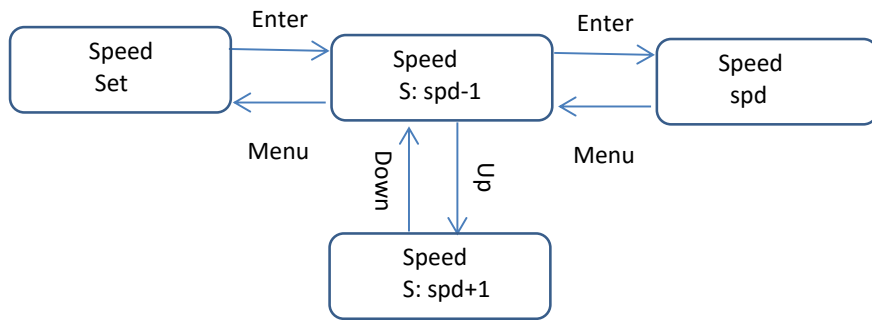

## Function & Setting

### Sound Active

The change of the laser pattern is controlled by sound, that is, the rhythm of the sound control the effect of the changing laser pattern. Turning the sensitivity knob in the clockwise direction to increase the fixture's sensitivity to sound, the knob in the counter clockwise direction to decrease. The laser diode will automatically turn off after 8 seconds when the music stops.

### AUTO

Auto cycles the built-in programs without being controlled externally. It has no laser OFF.

The mode allows a single unit to react to the beat of the music in the master mode.

1. Install the units in a suitable position (laying or appending).

2. Set dipswitch to select Sound Active or AUTO mode.

3. Turn on the unit power, the unit begins reset, then the unit begins working.

4. The unit will react to the low frequencies of music via the internal microphone.

Adjust the audio sensitivity knob on the back of the unit to make the unit more or less sensitive in sound active. The panel has LED indicating for sound active.

### Master-Slave Operation

This mode will allow you to link up to 32 units together without controller.

1. Install the units in a suitable position (laying or appending).

2. Choose a unit to function as Master mode, set dipswitch to select Sound Active or AUTO mode. The others must be set to Slave mode, set dipswitch to select Slave mode.

Potential laser injury hazard exists with this product! Read these Instructions carefully, which include important information about installation, safe use and service!

### Caution

- \* Avoid direct eye contact with laser light. Never intentionally expose your eyes or others to direct laser radiation.
- \* This laser product can potentially cause instant eye injury or blindness if laser light directly strikes the eyes.
- \* It is illegal and dangerous to shine this laser into audience areas, where the audience or other personnel could get direct laser beams or bright reflections into their eyes.
- \* It is a US Federal offense to shine any laser at aircraft.

### NON-INTERLOCKED HOUSING WARNING

- \* This unit contains high power laser devices internally. Do not open the laser housing, due to potential exposure to unsafe levels of laser radiation. The laser power levels accessible if the unit is opened can cause instant blindness, skin burns and fires.

## Installation

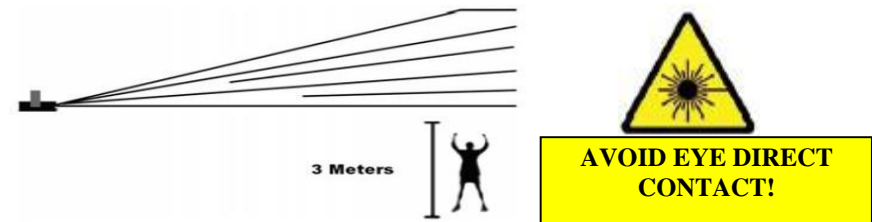

\* Laser effects projected 3 meters (9.8 ft) above the audience are eye safe. A survey should be taken to assess the likelihood of any reflective surfaces (such as high windows, chrome bars etc) bouncing stray beams back down into the audience.

\* Using a fastening clamps on the light and tight to the ceiling in a strong hook..

\* Make sure its correct power output and plug the power cable to the wall socket.

\* Power must be in earth! Power on the light.

\* Do not shoot the beams to the audience!

\* Do not look direct into the laser aperture once the laser light is ON. Please pay attention to the Laser Danger Warning Label!



The projector must be installed in a location with adequate ventilation, at least 50cm (20inches) from adjacent surfaces. Be sure that no ventilation slots are blocked.

### Caution

After setting up, and before public use, test laser to ensure proper function. Do not use if any defect is detected. Do not use if laser emits only one or two laser beams rather than dozens/hundreds, as this could indicate damage to the diffraction grating optic, and could allow emission of higher laser levels above Class 3B.

- Do not** point lasers at people or animals. Never look into the laser aperture or laser beams.
- Do not** point lasers in areas in which people can potentially get exposed, such as uncontrolled balconies, etc.
- Do not** point lasers at highly reflective surfaces, such as windows, mirrors and shiny metal. Even laser reflections can be hazardous.
- Never** point a laser at aircraft, this is a federal offense.
- Never** point un-terminated laser beams into the sky.
- Do not** expose the output optic (aperture) to cleaning chemicals.
- Do not** use laser if the laser appears to be emitting only one or two beams.
- Do not** use the laser if the housing is damaged, the housing is open, or if the optics appear damaged in any way.
- Never** open the laser housing. The high laser power levels inside of the protective housing can start fires, burn skin and will cause instant eye injury.
- Never** leave this device running unattended.

**\*During Assembly, operation, maintenance, please pay special attention to avoid possible exposure to laser and collateral radiation in excess of the accessible emission limits.**  
**\*Use of controls or adjustments or performance of procedures other than those specified herein may result in hazardous radiation exposure.**  
**\*Protective eye wear is typically required where direct viewing of a Class 3B laser beam may occur.**

### 5. Running Mode Setting

- \*Under **X/Y Run Set**, press **ENTER** into the secondary classification.
- \*Under secondary classification, press **UP/DOWN** to select Running mode: Run, Stop. Press **ENTER** to confirm and save. Under **Stop** mode, press **ENTER** to stop setting. Position **Pos** value, press **UP/DOWN** to increase or decrease 1 value, press **ENTER** to confirm and save. Press **MENU** back to the previous selection.

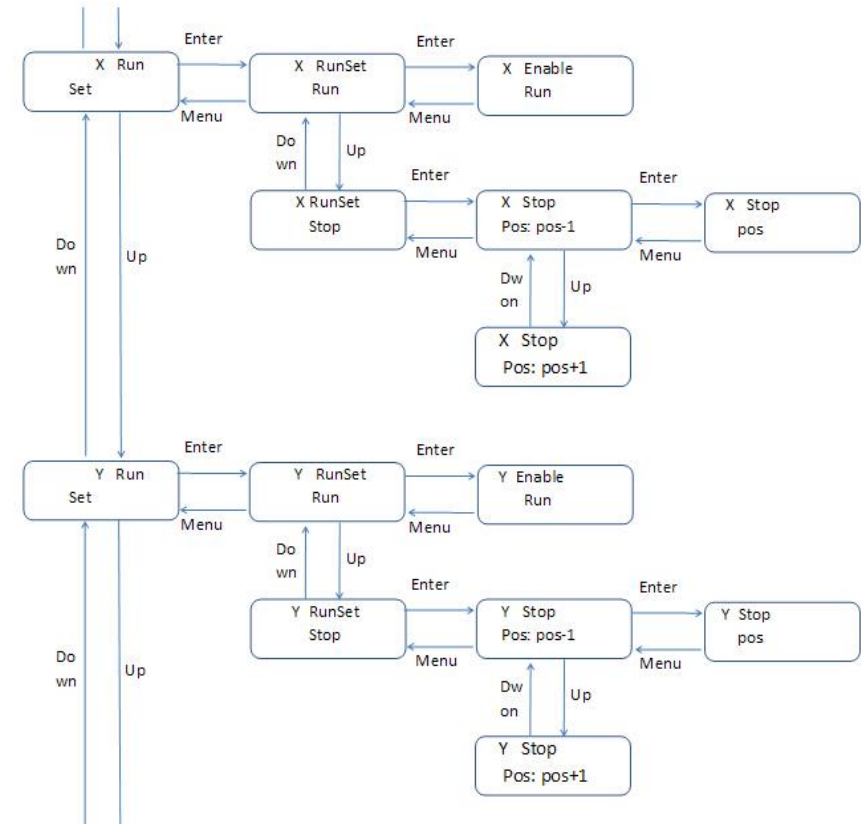

### 6. Speed setting

- \*Under **Speed Set**, press **ENTER** into the secondary classification
- \*Under secondary classification, press **UP/DOWN** to increase or decrease speed 1 value. press **ENTER** to confirm and save. Press **MENU** back to the previous selection.

3. DMX512 Address setting:

Add: 001---512 value

\* Under Address Set, press ENTER into DMX512 address setting secondary classification

\*Under secondary classification, press UP/DOWN to increase or decrease 1 value press ENTER to confirm and save. Press MENU back to the previous selection.

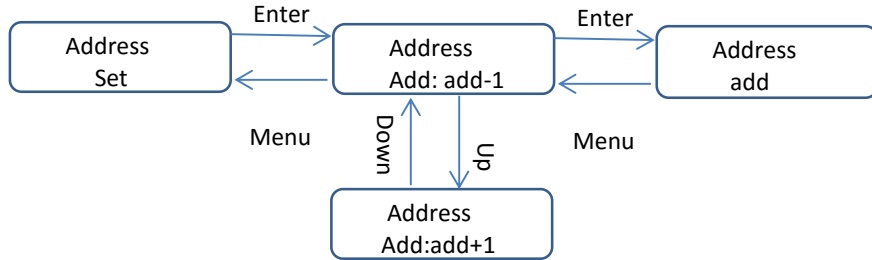

4. Mirror Symmetry mode

2 units moving head laser lights are linked via XRL cable and can be operated in Mirror Symmetry mode. This means X/Y mirror reverse.

\*Under X/Y Mirror Mode Set, press ENTER into the secondary classification.

\*Under secondary classification, press UP/DOWN to select Mirror Symmetry ON/OFF. Yes: ON, No: OFF.

press ENTER to confirm and save. Press MENU back to the previous selection.

\*One time change the Mirror Symmetry mode, the moving head light will reset one time.

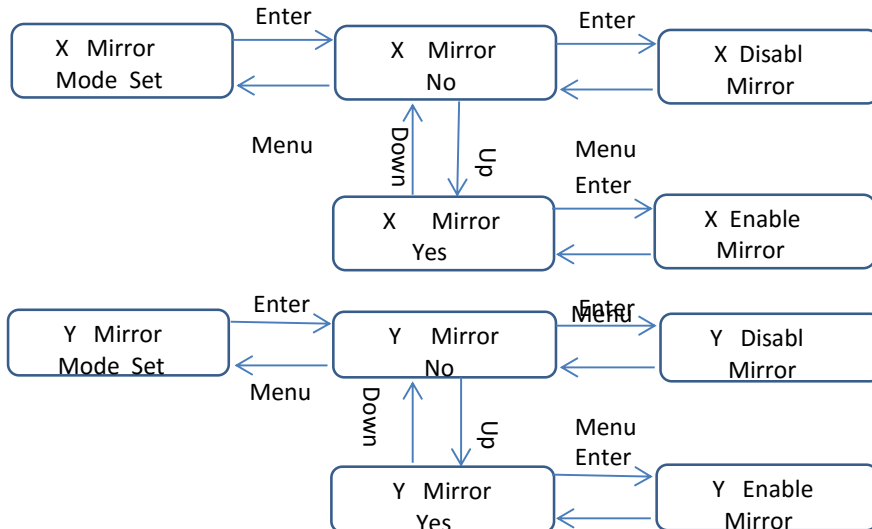

Cleaning

**Fixture Cleaning:** Due to fog residue, smoke, and dust cleaning the internal and external lenses should be carried out periodically to optimize light output.

1. Use normal glass cleaner and a soft cloth to wipe down the out- side casing.
2. Clean the external optics with glass cleaner and a soft cloth every 20 days.
3. Always be sure to dry all parts completely before plugging the unit back in.

Cleaning frequency depends on the environment in which the fixture operates (I.e. smoke, fog residue, dust, dew). In heavy use we recommend cleaning on a monthly basis. Periodic cleaning will ensure longevity, and crisp beam output.

Technical Specification

\* Voltage: bi-voltage 110V -220V-250V AC, 50HZ-60HZ/ Fuse: 2A/250V, Rated Power: 20W

\* Scanning: Micro-step motor scanning at big angle

\*Laser power: 100mW 532nm green DPSS, fat-beam laser diameter: 1.0 to 1.2cm

\* Laser class: **Class 3B**

\*Working Modes: Sound Active, AUTO, DMX512, Master/Slave

\*DMX channel: 6CH

\* Single fat beam laser has pre-programmed many kinds of effects. Under DMX mode, it can be operated with X position, X movement speed, Y position, Y movement speed, and flashing.

\* Sound and AUTO flashing

\*Horizontal moving angle: 540°, Vertical moving angle: 270°

\*Scanning: Tilt and Pan

\*2 units moving head laser lights are linked via XRL cable and can be operated in Mirror Symmetry mode. This means X/Y mirror reverse.

\*Vertual Operating platform: LCD802 indicator

\* Interface: 3 pins XLR jack for DMX or Maser-Slave linking

\*Net Weight: 3Kg, Gross Weight: 3.5Kg (in carton box)

\*Item Size: 180\*140\*270L \*W\*H=mm

\*Inner Box: 230\*200\*360mm (0.017CBM), Outer Box: 420\*380\*480mm (0.077CBM), 4pcs/carton

Front/Rear Panel



- 1. Laser aperture      2. moving head      3. handle      4. base
- 5. Sound active microphone      6. LCD Indicator for functions      7. MENU
- 8. UP      9. DOWN      10. ENTER      11. DMX or linking jack
- 12. Power jack      13. Power switch ON/OFF

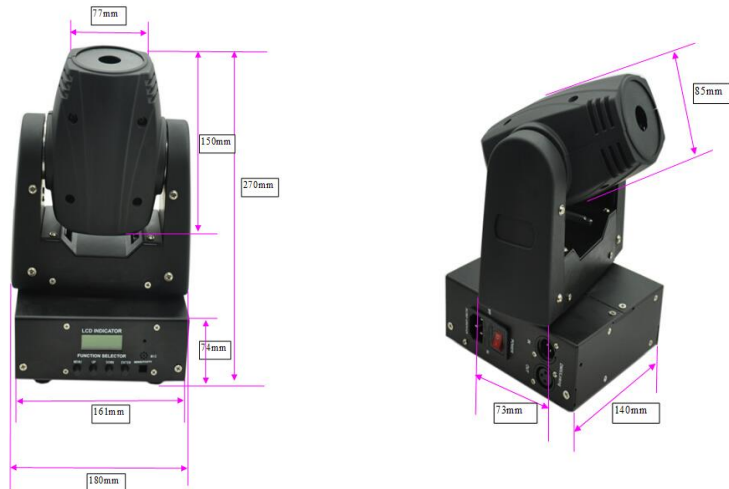

LCD Digital Operation Introduction

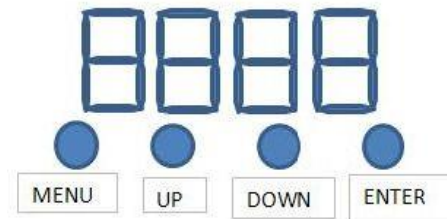

**Menu:** function selection or back to previous function  
**UP:** previous selection or increase  
**DOWN:** next selection or decrease  
**ENTER:** Confirm or save the selection

LCD0802 Display and Function

1. Power on the moving head laser light, then, the light is reset. LCD0802 displays:

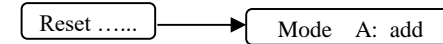

After reset, it displays the current working Mode and DMX512 address

Working Mode: Auto, Sound, DMX512, Master/Slave

Address: 001----512 value

2. Working Mode Setting:

Auto Mode: automatically running, default Master light sending signals to Slave lights.

Sound Mode: Running with Sound, Default to be Master light and sending signals to Slave lights

DMX512: DMX512 signal control

Slave Mode: slave light to accept Master signal.

\*In the **Menu Work Mode Set**, press Enter into the secondary classification

\*Under secondary classification, press **UP/DOWN** to select working mode and then press **ENTER** to confirm and save. Press **MENU** back to the previous selection.

